

4CH HD Driving Video Recorder

INSTRUCTION MANUAL

Thank you for purchasing this product.

For correct application and usage instructions, please read this instruction manual thoroughly.

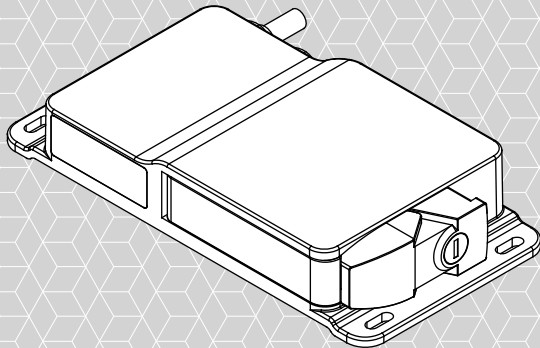

CONTENTS

PRECAUTION BEFORE USE	3
FEATURES	5
BOX CONTENTS	5
NAME AND FUNCTION OF EACH PART	6
INSTALLATION	7
OPERATION	9
PC VIEWER MANAGER	15
SPECIFICATION	23













PRECAUTION BEFORE USE

- !** Do not install the product where it cannot be mounted securely, or is exposed to excess vibrations.
- It may cause an accident or injury if the product comes loose from its mounting while driving.
- !** Avoid wiring the product to a voltage higher than the maximum specified.
- Excess voltage may cause an electric shock and/or fire.
- !** Do not place within the effective deployed area of an air bag.
- Doing so may cause a malfunction with the air bag, an accident and/or injury.
- !** Observe all air bag safety precautions when installing the product.
- Failure to do so may cause a malfunction with the air bag if the product is installed and/or wired incorrectly.
- !** Ensure the power socket is kept clean and free from dust at all times.
- Failure to do so may cause an electronic shock and/or fire.
- !** Do not insert foreign objects into a hole or crack in the body of the product.
- Doing so may cause an electric shock, fire and/or malfunction.
- !** Do not use should you suspect a problem with the device (e.g. smoke or a burning smell coming from the product).
- Immediately discontinue use and make enquiries with the supplier.
- !** Always install with the power disconnected. Only connect power after the install is completed.
- It may cause an electric shock or malfunction.
- !** Do not operate the product while driving.
- Doing so may cause an accident. Stop in a safe place to operate.
- !** Do not install the product where a sudden temperature increase may occur. Only use within the optimum voltage, temperature and humidity range. - It may cause a malfunction or explosion.
- !** Do not pull on any cords or wiring. Do not use with damaged wiring.
- It may cause a malfunction, electric shock and/or fire.
- !** Do not clean the exterior with alcohol, volatile chemicals or solvents.
- Such chemicals may cause damage to the surface and/or paint, or a malfunction and/or fire.



Please prevent the loss of power during an update.
If power is lost during an update, the product may no longer function.

- ⊘** Do not allow any object to come into contact with the product.
- An impact to the device may cause damage or a malfunction.
- ⊘** Do not place near a magnet.
- It may cause a malfunction.
- ⊘** Keep the internal GPS antenna free from any obstructions.
- Obstructions may cause a problem with GPS signal reception.
- ⊘** The GPS function has a loading time when first powered on.
- The GPS needs from a few seconds to a few minutes depending on signal reception strength.

-  A vehicle with metallic tinting on the front window could cause poor GPS signal reception.
-  Do not interfere with any wiring when the product is installed in an area with other wiring.
 - It may cause a malfunction or fire from a 'bundle' of electric wiring.
-  Use only the specified components.
 - If non-specified components are used, it may cause an accident or malfunction of the product.
-  After installation, ensure all wiring is secured and out of the way so as not to interfere with the actions of driving.
 - It may cause an electric shock or fire if exposed wiring comes into contact with the car frame.
 - It may cause an accident if any vehicle controls are restricted due to interference by the wiring.
-  Ensure the wiring will not contact moving parts (such as a seat rail), fasteners or the car frame.
 - It may cause a short circuit resulting in an electric shock and/or fire.
-  After installation, ensure the vehicle's brakes, lights, horn, etc. all operate correctly.
 - An accident, electric shock and/or fire may be caused if any of the above functions are impeded by the installation of this product.
-  The recording quality may be affected in areas with a sudden change in light, such as entering or exiting a tunnel.
-  When driving in low light conditions, turning on the vehicle's headlights will improve the recording quality.
-  When using a non-supplied power cable (e.g. if needing a longer cable), contact a specialty store. (The fuse box location will vary depending on each car manufacturer. Check the car manual before installation.)
-  To prevent excess vehicle battery drain, disconnect power to the product if you will not drive for an extended time (over three days). We recommend disconnecting even though this cable contains a feature to prevent battery drain.
-  Do not attempt to disassemble, repair or modify the product.
 - Doing so may cause a malfunction and/or injury. The warranty will be void. Make enquiries with the supplier for inspection and repair.
-  Ensure the product is installed level, with a memory card inserted.
 - No recordings can be saved without a memory card installed.
-  Use SD cards only for DVR recording.
 - The SD card used for recording must use the FAT32 file system. If the SD card is shared for both general usage and recording, the recorded video may become corrupt or cause serious errors to the SD card. In such cases, no warranty or compensation can be given. It is recommended to format the SD card using the PC viewer manager software.
-  The viewer does not run properly when the sound driver is not installed on the user's PC or if the sound device is disabled.
 - If the message 'Sound device open error' is displayed twice, please re-run the viewer installation after confirming that the sound device is working properly.

1 FEATURES

- HD / CVBS resolution
- TVI / AHD / CVBS camera compatible
- IP69K (waterproof/dustproof) / aluminium die-cast case
- Output: HD VIDEO OUT x1 / CVBS VIDEO OUT x1
- H-264
- Automatic recording when power is on (in the case of an external impact or if an accident occurs while driving)
- Exclusive PC Viewer Manager software
- SD card lock system
- Various audible alerts (memory card issue, events, firmware update etc.)
- External GPS antenna
- 3G shock sensor
- Free Voltage (DC 12V~24V, Max.32V)
- Supports triggers (connected to rear camera)
- Wi-Fi dongle for long distance Wi-Fi transfer (optional)
- Supports voice recording via external microphone (MIC) (optional)
- External emergency recording button (optional)

2 BOX CONTENTS

※ If the body and parts mentioned below are not included when you purchase this product, contact the shop where you purchased the product.

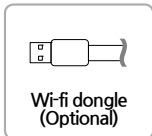
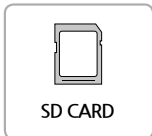
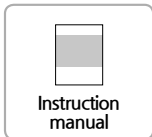

The images of each item shown above are for illustrative purposes only and may differ from the actual items supplied. Each item is subject to change without notice.

3 NAME AND FUNCTION OF EACH PART

4CH Digital DVR

1. LED lights
2. Forced power switch
3. SD card slot
4. Memory key lock

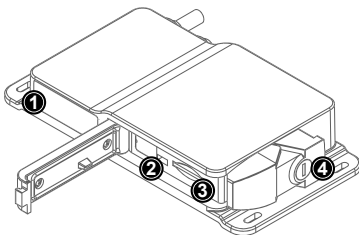

Cable Connection

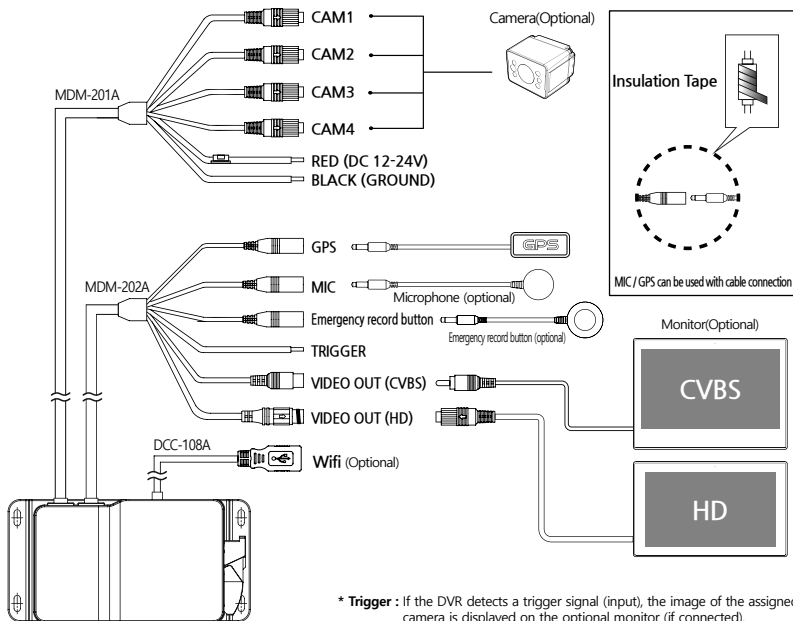

4 INSTALLATION



Please read the following points prior to installation.

- Turn off the product before installation, and ensure the vehicle key is not inserted and turned on at any time during the installation.
- Only use the cables supplied. Do not use any other unverified cable.
- Any vehicle with dark or metallic tinting may have a negative influence on the GPS signal strength.
- Be sure to eliminate potential wave interferences around the GPS antenna and completely separate from other devices and cabling, such as a hi-pass filter, navigation equipment etc.

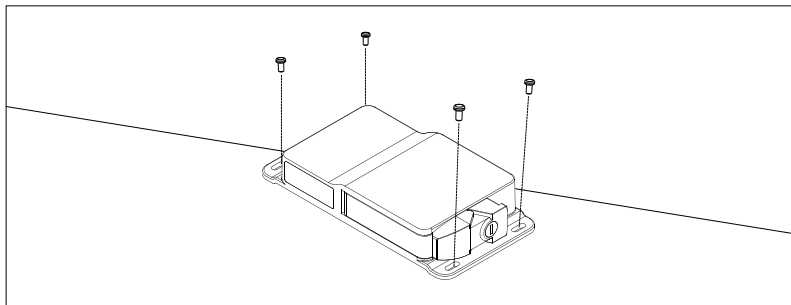

GPS antenna connection

Connect the DVR to a GPS antenna to collect data including driving route, speed, time, direction and location information.

* Recommended GPS antenna installation position



Ensure GPS antenna does not overlap the tinted section of the window.



Install with the "GPS" engraved side facing upward.



* Receiving a GPS signal could be impaired by tinting or a coating material on the window. It is not a product fault, but a situation caused by metallic tinting or a metal component in the glass such as heat/demister wires. In this case, relocate the antenna to a place where there are no obstructions.

* Before attaching the GPS antenna, clean the surface and then secure firmly with double-sided tape, making sure the "GPS" engraved side is facing upward. The attached double-sided tape will reach maximum strength after 24 hours.

LED lights on the DVR

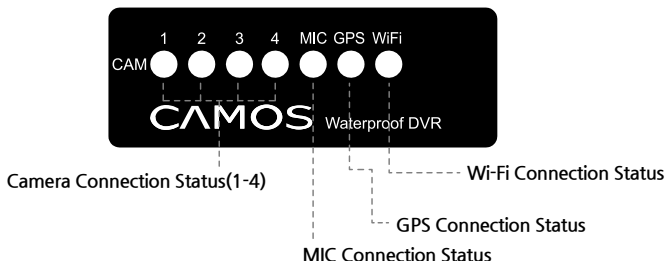

* Only the LEDs with a good connection to the external device are indicated. All camera LEDs will flash when an event occurs.

Buzzer & LED Operation

Status	Feature	CAM1 LED	CAM2 LED	CAM3 LED	CAM4 LED	MIC LED	GPS LED	Wi-Fi LED	Buzzer
Booting	Normal Booting	Blinking after turning on	Blinking after turning on	Blinking after turning on	Blinking after turning on	Turn on	Turn on	Turn on	○
	Booting Error	Turn off after turning on	Turn off after turning on	Turn off after turning on	Turn off after turning on	Turn off after turning on	Turn off after turning on	Turn off after turning on	○
Turn Off	Normal Turn Off	Turn off after turning on	Turn off after turning on	Turn off after turning on	Turn off after turning on	Turn off after turning on	Turn off after turning on	Turn off after turning on	○
Recording Mode	Driving(Normal)	Blinking	Blinking	Blinking	Blinking	-	-	-	-
	Shock(Event)	Blinking	Blinking	Blinking	Blinking	-	-	-	○
	External(Trigger)	-	-	-	-	-	-	-	-
Firmware	UP DATE	Blinking	Blinking	Blinking	Blinking	Blinking	Blinking	Blinking	○
Camera	Normal	Blinking	Blinking	Blinking	Blinking	-	-	-	-
	Error	Turn off after turning on	Turn off after turning on	Turn off after turning on	Turn off after turning on	-	-	-	○
MIC (AUDIO)	Connect	-	-	-	-	Turn on	-	-	-
	No Connection	-	-	-	-	-	-	-	-
GPS	Connect - Receiving	-	-	-	-	-	Turn on	-	-
	Connect - Not Receiving	-	-	-	-	-	Blinking	-	-
	No Connection	-	-	-	-	-	-	-	-
ETC	SD CARD FORMAT	Blinking	Blinking	Blinking	Blinking	Blinking	Blinking	Blinking	-

5 OPERATION



Please note the following before operating the product.

- Do not touch the device while driving.
- Connect the GPS, VIDEO OUT and MIC before turning on the vehicle.
- After powering on the device, it may reboot. This is not a device fault.
- Recording is only possible when the SD card is inserted.
- If the SD card is removed while in operation, some or all of the data may be lost.
- Always remove the SD card by using the "Safe Hardware Removal" option on a PC.

Powering On/Off & Removing the SD Card

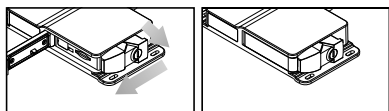

1. After inserting the SD card, the cover must be closed to turn the device on. If not, the device will not turn on.

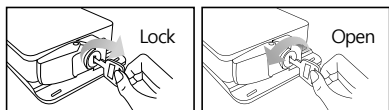

2. Always lock the device with the key lock in order to prevent the ejection of the SD card due to an accident or shock. (SD card key lock)

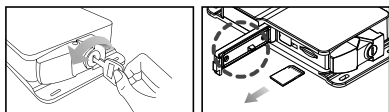

3. Unlock using the enclosed key, then open the cover and wait a minimum of two seconds before removing the SD card



Please insert the SD/micro SD card with the chip/contacts facing upward.

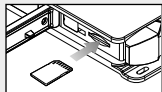

Damage to the SD card slot may occur if the SD card is forcibly inserted the wrong way. This may result in recording issues or failures.

Recording Status and LED Confirmation



Booting

1. All LED lights turn on for 12 seconds after successfully booting. Then, CAM 1 to 4 lights turn on for four seconds. CAM 1 to 4 lights will then flash every second for five seconds, after which drive recording will start.
- * Please check the power or SD card connection status if the device does not boot within 30 seconds.

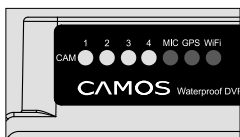

Recording Mode

1. CAM 1 to 4 LEDs will flash every second after recording starts.
2. If a shock (EVENT) occurs, the LEDs on CAM 1 to 4 flash five times within a second from the start to the end of the event.

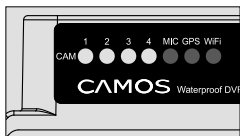

CAM 1,2,3,4

1. If the camera is connected, the corresponding LED light will flash every second. (E.g. when only CAM 1 is connected, the light for CAM 1 only will be on.)
2. CAM LED lights will not turn on if there is an issue with the corresponding camera's connection.

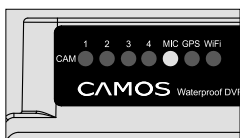

MIC

1. The MIC LED will turn on when a microphone is connected.
2. The MIC LED will be off when a microphone is not connected.

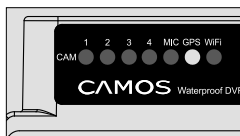

GPS

1. When a GPS antenna is connected, it begins searching for a signal. The GPS LED will turn on when the signal is received. The LED light flashes every second when the signal reception is poor.
2. The GPS LED will be off when a GPS antenna is not connected.

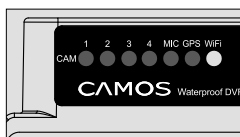

Wi-Fi

1. The Wi-Fi LED will turn on when the Wi-Fi is connected (E.g. when configuring FTP settings).
2. The Wi-Fi LED is turned off when the Wi-Fi is not connected.
3. The Wi-Fi LED flashes after connecting and when transmitting data.

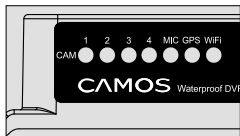

Finished Recording

1. All LEDs turn off and then turn back on at the end of a normal, successful recording.

Firmware update

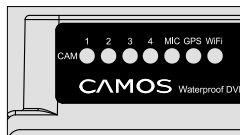

Firmware update

1. The previous version of firmware will be updated automatically if a new update file is found during initial booting.
2. All LEDs flash every two seconds until the firmware update finishes.
*** Please make sure the power stays on while updating.**



Please carefully read the below information if using an SD card over 64GB.

- The CAMOS DVR supports automatic formatting (FAT32) when a memory card larger than 64GB is first used.
- Only format memory cards using the PC Viewer Manager software.
- Proceed with the firmware update only after formatting the SD card via the PC Viewer Manager. (The firmware update might not proceed after formatting on a PC, depending on the file system selected (e.g. exfat). In this case, reformat using the PC Viewer Manager only, which will use the correct format (FAT32). The firmware update will now proceed as normal.)

Error Check

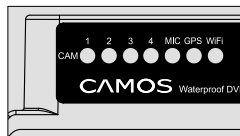

Error Check

1. All LEDs flash every second when an error occurs or the SD card is removed with power being connected. There will be a continuous audible beep until the SD card is re-inserted or the power is turned off.
*** The device turns on/off when the cover is opened and closed. Please insert or remove the SD card by opening and closing the cover with the engine off in order to prevent damage to recorded data stored on the SD card.**

RECORDING MODE & TIME

Continuous Recording Section Event

Recording Section

1. Continuous Recording (NORMAL) *Normal recording videos are saved in the NORMAL folder.

Continuous Recording : DVR will record in two-minute files.



2. Event Recording (EVENT) *Event recording videos are saved in the EVENT folder.

E.g. 1: In the event of an accident

Records 10 seconds before and 20 seconds after the event with an audible beep (30 seconds overall).

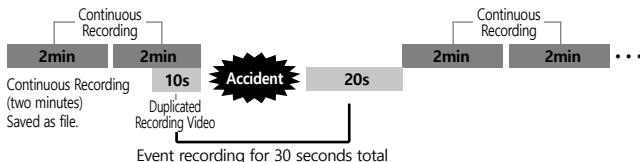

E.g. 2: In the event of an accident within 15 seconds after recording started

Continuous recording file (15-second video) / event recording file. (30 seconds)

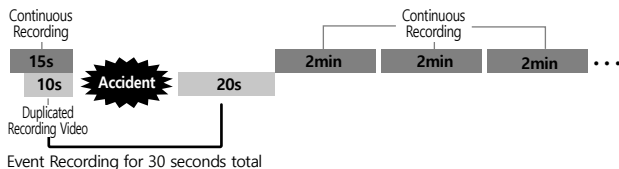

E.g. 3: Consecutive events

The additional event video is generated after the first event video.

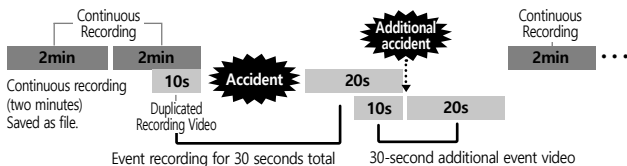

* An additional event video is not generated in the middle of an event.

3. Forced Recording (MANUAL)

*Forced recording videos are saved in the MANUAL folder.



1) Extension Emergency Button (optional)

Install the emergency recording button within easy reach of the driver to start a forced recording when necessary.

* This button is connected to the remote control receiver input.

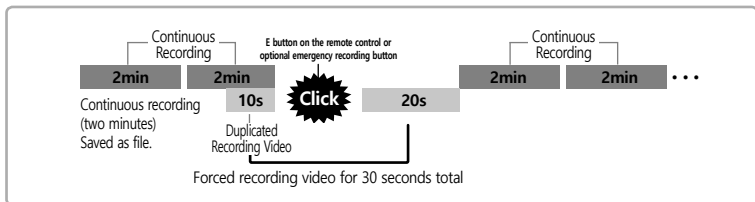

※ VIDEO RESOLUTION

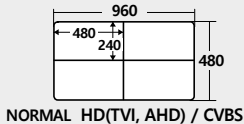
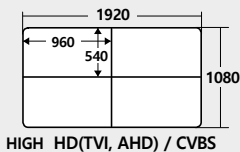

※ Folder structure on the SD card

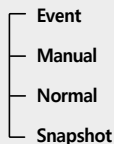

When using a 512GB SD card with either of the 960H video resolutions, the default two-minute file recording time is increased to four minutes.



The time to save the recorded video can vary and depends on the used capacity of the SD card, amount of cameras used, configured settings and recording quality.



In some cases, videos have one to two seconds of duplicated footage with the next video, which helps to prevent image loss. This is not a fault. E.g. Normal video time of 2 min. and 2s.

SCREEN FEATURES / SCREEN LAYOUT

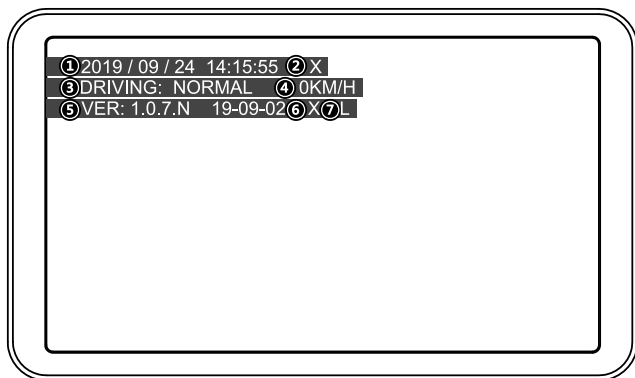

- 1. Current Time** Displays the current date and time.
- 2. GPS Connection** Displays the GPS connection status (connected = O, not connected = X).
- 3. Recording Status** Displays the recording status (NORMAL / GSENSOR / MANUAL).
- 4. Speed** Displays the speed when the GPS is connected (Km/h, MPH).
- 5. Version Information** Displays the firmware version.
- 6. MIC Connection** Displays the microphone (MIC) connection status (connected = M, not connected = X).
- 7. Image Quality** Displays the recording quality (normal image quality = L / high image quality = H).

※ Screen Configuration with Single/Multiple Cameras Connected.



Example of screen configuration with only one connected.



Example of screen onfiguration with four cameras camera connected.

6 PC VIEWER MANAGER

Recommended Specifications for Running PC VIEWER MANAGER

CPU : Pentium Series or higher
OS : WINDOWS 7/ 8/ 10

Memory : 2GB RAM
HDD : 1GB Free Space
Authorized User : Administrator



- * If videos saved in the SD card are more than a week older than the current PC time, when you open a file in the PC VIEWER, a message is displayed that states the SD card needs to be formatted.
- * Please format the SD card regularly to prevent errors.
- * If the recording list does not show up in PC VIEWER, check the drive letter selected to ensure you are looking on the SD card.

Recorded File Naming Convention



The file naming convention is "Channel_Numbering_Date_Time_N/A_N/A_Recording Mode". For the end letter (recording mode): "N" stands for normal recording, "G" stands for event recording by an impact, and "S" stands for Wi-Fi setting (saving images during an impact). E.g. ch1_0183_20200128_180426_753_56991_N.avi
The file was recorded on 28th Jan 2020 18:04:26 using ch1, normal recorded file.

Organize ▾	Share with ▾	Burn				
	Name	Date modified	Type	Size		
★ Favorites						
Desktop						
Recent Places						
Libraries						
Documents						
Music						
	ch1_1251_20140305_081634_606_119902_...	2014-03-05 오전 8:...	Video Clip	80,070 KB		
	ch1_1252_20140305_081834_575_119902_...	2014-03-05 오전 8:...	Video Clip	94,978 KB		
	ch1_1253_20140305_082034_542_119902_...	2014-03-05 오전 8:...	Video Clip	94,504 KB		
	ch1_1254_20140305_082234_510_119902_...	2014-03-05 오전 8:...	Video Clip	94,790 KB		
	ch1_1255_20140305_082434_478_119902_...	2014-03-05 오전 8:...	Video Clip	94,851 KB		
	ch1_1256_20140305_082634_446_119902_...	2014-03-05 오전 8:...	Video Clip	94,263 KB		



- * The channel selection window appears when a new SD card is recognized or after the SD card is formatted through the viewer. Please select the channel.
- * Please install PC Viewer Manager onto your PC from the "Viewer" folder in the SD card.
- * Please remove the "Viewer" folder after the installation of PC Viewer Manager.
- * After formatting the SD card, you can download the PC Viewer Manager setup file from the Camos website: www.camos.co.kr.



PC VIEWER MANAGER INSTALLATION ISTRUCTION

※ Double-click setup.exe to start the installation.

1. Double click [setup.exe].



2. Click [Next] on the setup wizard.



3. Specify the installation location and click [Next].



4. Click [Next] at Confirm Installation step.



◀ Installation Progress Screen

5. Click [Close] at Installation Complete step.

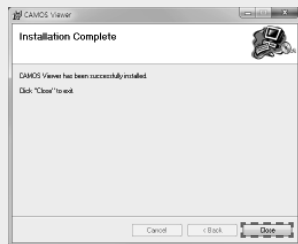

※ Viewer's Software is subject to change without notice.
The latest viewer version is available for download from CAMOS website.

User Interface Instructions



- 1. Play screen** Displays quad recorded video.
- 2. 3G sensor** Displays 3G sensor information.
- 3. Volume control** Adjusts sound (mute/volume +/-)
- 4. Playback control** Previous file/Backward/Play(pause)/Forward/Next file
- 5. Play speed control** Adjusts playback speed (x1/4 ~ x4)
- 6. Minimize** Minimizes the program window to the taskbar
- 7. 1:1 screen** Fit the recorded video to the viewer window size
- 8. Full screen** Displays the recorded video in full screen (press ESC to return to normal playback screen).
- 9. Maximization** Maximizes the program window to monitor screen size.
- 10. Exit** Ends the program.
- 11. Open file** Opens a recorded video file.
- 12. File search** Searches the file list by date and time.
- 13. Map** Displays driving route on the map.
- 14. GPS info.** Displays GPS information.
- 15. Output of Event Report** Displays report format data.
- 16. Send file** Saves the data in bmp or avi format.
- 17. Configuration** Change setting values.

Recorded Video Playback Instructions

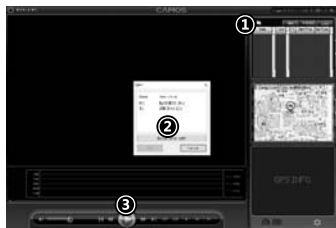

Disk Read

1. ① Click on the "Folder" button to display the Disk Read screen.
2. ② On the Disk Read screen, select the connected drive and press the OK button to display a list of files.
3. If the connected drive cannot be verified, directly browse and read the recorded file after clicking on the "Open Another Folder" button.

File List Change

1. ④ The Viewer software can convert and display all files, event recording files, and LOG data in the file list.
2. [ALL]: Show all files on the SD card.
3. [EVENT]: Display event files on the SD card.
4. [LOG]: Identifies the type of event recorded and displays a timestamped list.

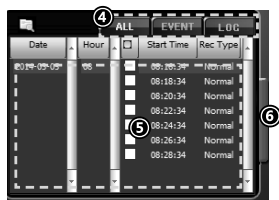

File Playback

1. ⑤ Double click on a specific time slot to continuously play through the videos.

Expanded file list screen

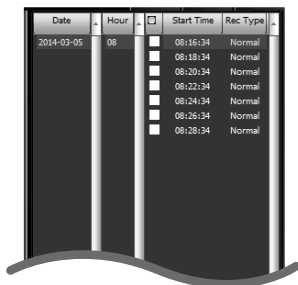

Expand File List

1. ⑥ Click the "Expand list" button to open a window to the right of the screen, showing more files. Click ⑥ again to return to the original file list.

Mode Change



EX 1 : 4 SPLIT

1. Four images are displayed after running the viewer and selecting a file (refer to image EX1)
2. The selected part of the screen is zoomed-in when you double click it during playback. Double click it again to return to the previous screen (refer to image EX2).



EX 2 : CAM 1



CAM 2



CAM 3



CAM 4

Map Information Instruction



Click the ① button to expand the map screen.

Click the ① button again to return to the main display.

Checking GPS information

It is possible to view the vehicle's speed, time, direction and location information at the time video was recorded.

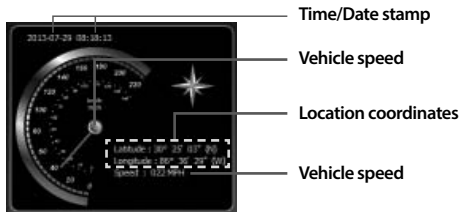

Additional Functions



Click the ① button to show the accident report. Click the Add Memo button to comment on the pin board of the accident report. This will appear on the printed image. Click the print out button to print.



Click the ② button to save an image of the currently playing video.

1. Backup Type : Click "AVI" to save as a video.
Click "BMP" to save as an image.
2. Select the save location on the PC

Configuration

Click the Configuration button to open the Configuration window.

The screenshot shows a 'CONFIGURATION' window with the following sections:

- Speed Unit:** Radio buttons for Km/h and MPH.
- Video Quality:** Radio buttons for High and Normal.
- 3G Sensor:** Six radio buttons labeled 0 through 5.
- MIC ON:** A checked checkbox.
- Time Setting:** A date/time picker showing 2020, 11, 12, 10, 13, 30, and a 'sync' button.
- Standard:** A dropdown menu showing 'UTC +00:00 London, Lisbon' and a 'Daylight Saving' checkbox.
- User Password:** Input fields for 'Input Password' and 'Confirm Password'.
- Car Number:** An input field containing '001'.
- Memory:** A dropdown menu showing 'BLACKBOX (16)' and a 'Format' button.
- UPLOAD FILE:** Radio buttons for 'OFF' and 'ON'.
- JPG/AVI:** A dropdown menu showing 'AVI'.
- FTP URL:** An input field containing '175.210.***.* /VOLI/ ***'.
- FTP ID:** An input field containing 'CD-2004MT'.
- FTP PW:** An input field containing '***'.
- AP SSID:** An input field containing 'camos'.
- AP PW:** An input field containing '***'.
- Buttons:** 'DEFAULT' and 'SAVE' buttons at the bottom right.

- | | |
|--------------------------|---|
| 1. Speedometer Unit | Selects the units for GPS speedometer (Km/h/MPH). |
| 2. Recording Quality | Sets the quality of recording. (High/Normal) |
| 3. Shock Sensitivity | Sets sensitivity of the 3G sensor [6 options: 1(insensitive) → 5(sensitive) / 0(off)] |
| 4. Audio Recording | Selects whether audio recording is enabled. |
| 5. UTC | Selects the Universal Time Coordinated.
(Sync button displays the time set on the computer) |
| 6. World Standard Time | Selects the world standard time. |
| 7. Summer Time Apply | Applies daylight savings time. |
| 8. User password setting | Sets password in the PC-viewer.
(up to eight digits, special characters/numbers/letters available) |
| 9. Car Number setting | Sets a user car number to be displayed in the screen during recording. |



- * UTC time is the initial setting value.
- * Please select your city and click the button 'sync' to set your time.
- * Time would be set accurately, if you use our GPS for video recording.

Click Configuration button to open the Configuration Window.

The screenshot shows a 'CONFIGURATION' window with the following sections and callouts:

- Speed Unit:** Radio buttons for Kmh/h and MPH.
- Video Quality:** Radio buttons for High and Normal.
- 3G Sensor:** Radio buttons 0 through 5.
- MIC ON:** A checked checkbox.
- Time Setting:** Includes an 'Apply' checkbox, a date/time picker (2020-11-12 10:13:30), a 'Standard' dropdown (UTC +00:00 London, Lisbon), and a 'Daylight Saving' checkbox.
- Memory:** A dropdown menu showing 'BLACKBOX (E)' and a 'Format' button.
- Upload File:** Includes 'OFF' and 'ON' radio buttons, a 'JPG/AVI' event dropdown, an 'FTP URL' field, and 'FTP ID', 'FTP PW', 'AP SSID', and 'AP PW' fields.
- User Password:** Fields for 'Input Password' and 'Confirm Password'.
- Car Number:** A text field containing '001'.
- Buttons:** 'DEFAULT' and 'SAVE' buttons at the bottom right.

Numbered callouts (10-15) are placed over the window to highlight specific features: 10 (Version Info), 11 (Memory), 12 (SD card Format), 13 (Default Setup), 14 (Save), and 15 (WiFi setting).

- | | |
|--------------------|--|
| 10. Version Info. | Displays software version and information. |
| 11. Memory | Check the path to the SD card |
| 12. SD card Format | Formats the connected SD card. |
| 13. Default Setup | Resets all settings to factory default. |
| 14. Save | Saves the setting(s). |
| 15. WiFi setting | Set up for Wi-Fi (optional) |



The Viewer settings are saved to the connected SD card. If you connect and use multiple storage media at the same time, please be sure to check the location of the SD card written in [11 Memory] as the settings from another drive may be overwritten or applied.



The following characters are available to input for the configuration setting.

- FTP URL : English Alphabet, Arabic Numerals, _ - : / .
- FTP ID : English Alphabet, Arabic Numerals, _ - : + . ,
- FTP PW : English Alphabet, Arabic Numerals, _ - : + . , ! @
- AP SSID : English Alphabet, Arabic Numerals, _ - : + . , ! @, Space bar
- AP PW : English Alphabet, Arabic Numerals, _ - : + . , !, Space bar

7 SPECIFICATION

Video signal	Input	4 Channel input (TVI or CVBS)
	Output	HD 1 Output / CVBS 1 Output
Audio signal		1 Input
Recording	Resolution	4Channels HD(1920x1080), CVBS(1920x1080)
	Frame	30fps
	Mode	Normal / Event (G-sensor) / Manual
Compression		H.264
Memory		SD Card (min.16GB ~ max.512GB)
Power supply		DC 12~24V (with super cap) max.32V
Operating temperature		-10°C ~ 60°C
Storage temperature		-20°C ~ 70°C
Dimension (W/D/H)		198 x 34.5 x 100 mm
Weight		822g (DVR Only)

For further information please contact:

support@trailervision.co.uk

01733 246473

User Manual